



>>>>> abyss[®] slides





Abyss® is among the films, which have written history in terms of their special effects, it was filmed by James Cameron in 1989.

Since 2007, Abyss® by system klarer has also stood for spectacular effects and represents a concise further development of well-known waterslides.

Emerging from a high-speed Turbo Slide, the user shoots into a large barrel, the core of the system. After one or several circuits, the user emerges from the gorge, presumably into the deep. From there, he can land directly in the pool or is guided to the run-out basin in the lower part by a Tube Slide.

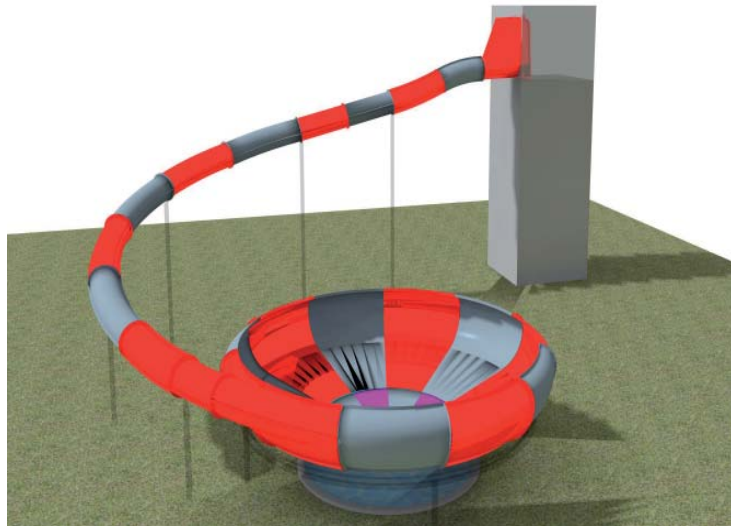

This helps to realise 3 different effects, that of the Turbo Slide, the barrel with gorge and a Tube Slide.

As well as the high safety factor, this system offers the option of fitting an all-year-round pool, making it suitable as an attraction for any pool.



Technical information

Dimensions:	Starting tube Ø 80 cm Landing tube Ø 120 cm
Capacity:	100 people/hour
Water volume:	120 m ³ /h
Gradient:	20-35%
Suitable from:	Age 8

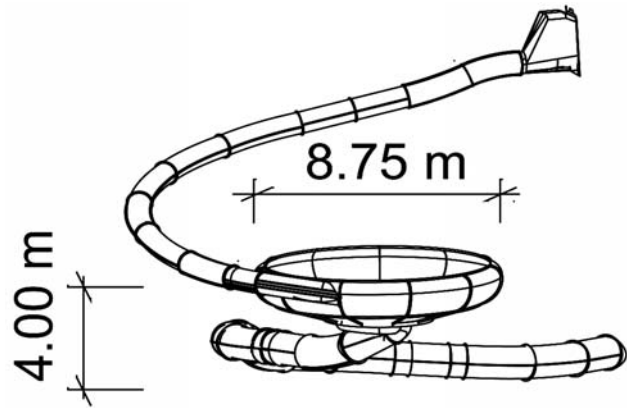

The Abyss can be equipped with the following run-out systems:

in a pool:	-plump runout -Sofa Spezial
without pool	-Integra -Sofa -Flat-Water runout -Universa



plump runout



Sofa Spezial

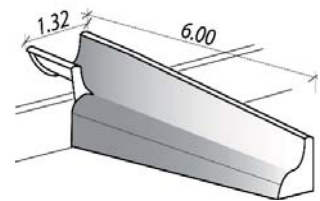

Integra

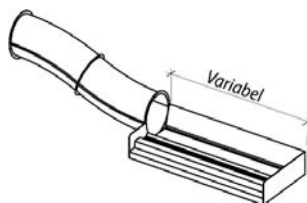

Sofa

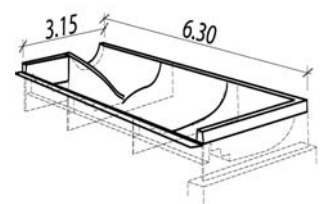

Flat-Water runout

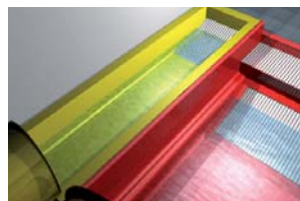
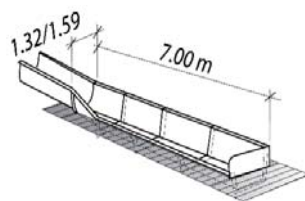

Universa

